

June 30, 2021

Ms. Jessica Chavez
City of Santa Fe
120 S. Federal Place Suite 101
Santa Fe, New Mexico 87501

Dear Ms. Jessica Chavez:

Battery Systems respectfully submits to City of Santa Fe our proposal for ITB #21/41/B for Automotive/Heavy Equipment Parts, Supplies, and/or Services. Enclosed you will find the following bid documents:

- Bid Submittal Documents
- Battery Systems Advantage
- Battery Systems Check & Charge Policy
- Battery Systems Safety Disposal Sheet

Thank You for considering Battery Systems as your *Single Source Solution!*

With more than 65 years' experience & over 100 locations, Battery Systems is the largest independent battery distributor in the United States. Partnering with more vendors to maintain the largest inventory in the industry, Battery Systems is dedicated to providing our customers the best *Service, Selection & Value.*

Should you have any questions or need any additional information, please do not hesitate to contact either the Battery Systems Bids Department or your local Battery Systems Albuquerque location.

Sincerely,



Chris Tschombor

Regional Manager

bids@batterysystems.net

310-667-9320

City of Santa Fe

Invitation to Bid

Agreement

Automotive/Heavy Equipment Parts, Supplies, and/or Services

ITB # 21/41/B

NIGP Commodity Code: 065, 072, 075, 928

Bid Due Date and Time: June 30, 2021 2:00 PM Mountain Standard Time

Bidder MUST complete as applicable and sign the following in order for the Bid to be valid (type or print clearly):

Company Name: Battery Systems, Inc. Address: 12400 Industry St.
dba (if applicable): _____ Garden Grove, CA 92841
Co. Email: bids@batterysystems.net
Co. Phone No.: 310-667-9320
NM Gross Receipts Tax # (CRS) 03-267715-00-4 Federal Tax ID # 77-0437059

Payment terms: Net 30 (e.g., Net 30. Discount will not be considered in computing the low bid, see “Terms and Conditions”)

F.O.B. Point must be Destination, unless otherwise indicated in the Invitation to Bid.

Contractor’s Delivery: 24 Hrs ARO (May be considered in the award) Will establish a delivery schedule with the City after contract award.
Same day Hot Shot if ordered by 10AM.

Authorized Signature:  _____ Print or type name: Chris Tschombor
Signatory Email: bids@batterysystems.net Phone No: 310-667-9320

* It is your responsibility as a bidder to ensure your bid is correct and accurate.

If you have any questions regarding this ITB please contact:

Procurement Specialist: **Jessica Chavez** Telephone No.: **(505) 629-8351** Email: **jjchavez@santafenm.gov**

No amendment will be issued later than three (3) days prior to the date for receipt of bids, except an amendment withdrawing the bids or one which includes postponement of the date for receipt of bids.

If applicable, Bidder acknowledges receipt of the following amendment(s):

Amendment No. None Dated: _____ Amendment No. _____ Dated: _____

Bids are subject to the “Terms and Conditions” shown on the attached pages of this document, and any additional bidding instructions or requirements. NOTE: if you decide not to bid, do not return this document.

Price Schedule:

Item	Unit	Article and Description	Unit Price
1.	Hourly	Mechanical Repairs; Labor Rate	\$
2.	Hourly	Maintenance and repairs; Labor Rate	\$
3.	Hourly	Electric Hybrid Maintenance/Repairs Labor Rate	\$
4.	Hourly	Compressed Natural Gas Inspections Labor Rate	\$
5.	Hourly	Body Repairs	\$
6.	Hourly	Standard Transmission Repairs/Rebuilds; Labor Rate	\$
7.	Hourly	Automatic Transmission Repairs/Rebuilds Labor Rate	\$
8.	Hourly	Transmission Fluid Change, filters, pan gaskets and band adjustments	\$
9.	Hourly	Engine Rebuilds	\$
10.	Hourly	Front Differential; Labor Rate	\$
11.	Hourly	Rear Differential; Labor Rate	\$
12.	Hourly	4x4 Transfer Case; labor Rate	\$
13.	Hourly	Tear Down Charge – Cost is driven by total labor hours involved. In the event the tear-down becomes a part of the repair, this fee goes away and is rolled into repair costs.	\$
14.	Hourly	Mobile Service Rate; explain when charges began and end	\$
15.	Hourly	Emergency Service, (After Hours 5:00 pm to 7:00 am)	\$
16.	Hourly	On Site Mobile Services (City Yard)	\$
17.	Per Mile	Mileage charge for onsite mobile services	\$
18.	Discount	Discount off Manufacturers List Price for Parts and Supplies \$.01 to \$500	% See attached price sheets
19.	Discount	Discount off Manufacturers List Price for Parts and Supplies \$501 to \$1,000	% See attached price sheets
20.	Discount	Discount off Manufacturers List Price for Parts and Supplies \$1,001 and greater	%
21.	Quart	Motor Oil (Gasoline Engines) (Major Brands Only) 4, 6,8 CYL	\$
22.	Quart	Motor Oil (Diesel Engines) (Major Brands Only)	\$
23.	Quart	Low Ash Motor Oil (CNG Engines)	\$
24.	Quart	Hydraulic Oil AW46	\$
25.	Quart	Transynd Transmission Fluid	\$
26.	Quart	Automatic Transmission Fluid	\$
27.	Per Gallon	Antifreeze	
28.	Each	Gasoline Environmental Disposal Charge	\$
29.	Each	Diesel Environmental Disposal Charge	\$
30.	Each	Used Oil Environmental Disposal Charge	\$
31.	Each	Antifreeze Environmental Disposal Charge	\$
32.	Each	List any other Misc Fee – Contractor must be able to justify these fees and cannot just add a fee onto the total job price.	\$

Sheet 6 - Manufacturers Percent (%) - Off						
Offeror may list by Manufacturer / Manufacturer by Category / or by Line Item (Supply Electronic Copy of Manufacturers Price List / Published Price List)						
For pricing purposes, all quantities shall be "1 each" or "1 pkg" / "1 box" / "1 box", if packaged in bag or box quantities						
Item	Manufacturer / Description	UOM	Make / Model	MSRP or / Published Price List	Percent (%) - Off	MPS Discounted Price
1	EXIDE - See attached price sheets					
2	CENTENNIAL AGM - See attached price sheets			MSRP listed in gray Suggested Retail column		Bin Number column
3						
3	ODYSSEY - See attached price sheets			MSRP listed in gray Suggested Retail column		Bin Number column
4	OPTIMA - See attached price sheets			MSRP listed in gray Suggested Retail column		Bin Number column
4						
5	U.S. Battery - See attached price sheets			MSRP listed in gray Suggested Retail column		Bin Number column
5						
10						
11						
12						
13						
14						
15						
16						
17						
18						
19						
20						
USE ADDITIONAL SHEETS IF NEEDED (Supply Electronic Copy of Manufacturers Price List / Published Price List)						

Battery Systems, Inc.
Company Bidding



Distributed By:



SUGGESTED CUSTOMER PRICES - ALL PRICES QUOTED EXCHANGE

BCI GRP SIZE	PART NUMBER	CORE CLASS	CCA				VOLTS	MAXIMUM DIMENSIONS INCHES			TERM TYPE	PRICE	DIST PRICE	SUGGESTED RETAIL
			CCA	CA	RC	AH		LENGTH	WIDTH	HEIGHT				
EXIDE® MARATHON® MAX – AGM SEALED AUTOMOTIVE BATTERIES – MAINTENANCE FREE* – 4 YEAR FREE REPLACEMENT														
H5/L2/47	MX-H5/L2/47-EX	A	680	850	100	60	12	9 1/2	6 7/8	7 1/2	A	133.29	266.59	380.84
H6/L3/48	MX-H6/L3/48-EX	A	760	950	120	70	12	11	6 7/8	7 1/2	A	135.39	270.79	386.84
H7/L4/94R	MX-H7/L4/94R-EX	A	800	1000	140	80	12	12 3/8	6 7/8	7 1/2	A	143.60	287.20	410.29
H8/L5/49	MX-H8/L5/49-EX	A	850	1060	160	90	12	13 7/8	6 7/8	7 1/2	A	150.32	300.64	429.49
H9/L6/95R	MX-H9/L6/95R-EX	A	950	1185	190	105	12	15 7/16	6 7/8	7 1/2	A	156.63	313.27	447.53
24	MX24-EX	A	700	875	120	70	12	10 1/4	6 13/16	8 7/8	A	136.89	273.78	391.11
24F	MX24F-EX	A	710	885	120	70	12	10 15/16	6 13/16	8 11/16	A	136.89	273.78	391.11
34	MX34-EX	A	740	925	115	60	12	10 1/4	6 13/16	7 3/4	A	128.76	257.53	367.90
35	MX35-EX	A	650	800	100	55	12	9 1/16	6 15/16	8 7/8	A	136.89	273.78	391.11
51R	MX51R-EX	A	435	540	75	41	12	9 3/8	5 1/16	8 3/4	A	123.46	246.93	352.76
S46B24R	MX51JIS-EX	A	410	510	75	41	12	9 5/16	5 1/16	8 15/16	A	123.46	246.93	352.76
65	MX65-EX	A	750	935	120	68	12	12 1/16	7 9/16	7 7/16	A	135.47	270.95	387.07
78	MX78-EX	A	740	925	115	60	12	10 15/16	7 5/16	7 1/4	A	128.76	257.53	367.90
EXIDE® MARATHON® AUX – AGM AUXILIARY AUTOMOTIVE BATTERIES – 2 YEAR FREE REPLACEMENT														
400	M14AUX-EX	M	170	210	20	14	12	5 7/8	3 7/16	5 3/4	M6	87.79	175.58	250.83
EXIDE® MARATHON® – ENHANCED FLOODED BATTERY (EFB) AUTOMOTIVE BATTERIES – MAINTENANCE FREE* – 4 YEAR FREE REPLACEMENT														
24F	M24F-EX	A	750	935	120	76	12	10 3/16	6 3/4	8 5/8	A	107.61	215.23	307.47
27F	M27F-EX	A	810	1010	140	77	12	12	6 13/16	8 11/16	A	106.32	212.65	303.79
34	M34-EX	A	750	935	120	76	12	10 3/16	6 13/16	7 7/8	A	103.66	207.33	296.19
35	M35-EX	A	585	730	100	65	12	8 15/16	6 3/4	8 3/4	A	108.65	217.31	310.44
H5/L2/47	M-H5/L2/47-EX	A	650	810	110	61	12	9 1/2	6 7/8	7 1/2	A	111.47	222.94	318.49
H6/L3/48	M-H6/L3/48-EX	A	750	935	120	74	12	11	6 7/8	7 1/2	A	113.55	227.11	324.44
H8/L5/49	M-H8/L5/49-EX	A	850	1060	170	98	12	13 7/8	6 7/8	7 1/2	A	128.55	257.11	367.30
51R	M51R-EX	A	500	625	90	50	12	9 5/16	4 15/16	8 11/16	A	101.25	202.51	289.30
65	M65-EX	A	750	935	130	84	12	11 1/4	7 7/16	7 7/16	A	106.86	213.73	305.33
78	M78-EX	A	750	935	120	76	12	10 3/16	6 3/4	7 3/16	S	103.66	207.33	296.19
H7/L4/94R	M-H7/L4/94R-EX	A	770	960	150	85	12	12 7/16	6 15/16	7 7/16	A	121.64	243.29	347.56
96R	M96R-EX	A	600	750	110	61	12	9 1/4	6 7/8	6 7/8	A	96.95	193.90	277.00
124R	M124R-EX	A	700	875	120	68	12	10 3/16	6 7/8	8 7/16	A	105.62	211.25	301.79
EXIDE® SPRINTER® MAX – AUTOMOTIVE BATTERIES – MAINTENANCE FREE* – 3 YEAR FREE REPLACEMENT														
24	SX24-EX	A	750	935	120	63	12	10 3/16	6 3/4	8 5/8	A	78.34	156.69	223.84
24F	SX24F-EX	A	750	935	120	63	12	10 3/16	6 3/4	8 5/8	A	78.34	156.69	223.84
27	SX27-EX	A	750	935	120	63	12	12	6 13/16	8 11/16	A	80.57	161.15	230.21
27F	SX27F-EX	A	750	935	120	63	12	12	6 13/16	8 11/16	A	80.57	161.15	230.21
34	SX34-EX	A	800	1000	120	63	12	10 3/16	6 13/16	7 7/8	A	78.55	157.11	224.44
35	SX35-EX	A	650	810	100	54	12	8 15/16	6 3/4	8 3/4	A	80.43	160.86	229.80
40R	SX40R-EX	A	650	810	105	56	12	10 5/8	6 15/16	6 15/16	A	79.61	159.22	227.46
H5/L2/47	SX-H5/L2/47-EX	A	650	810	100	61	12	9 1/2	6 7/8	7 1/2	A	92.59	185.19	264.56
H6/L3/48	SX-H6/L3/48-EX	A	750	935	120	70	12	11	6 7/8	7 1/2	A	91.71	183.42	262.03
H8/L5/49	SX-H8/L5/49-EX	A	950	1185	170	90	12	13 7/8	6 7/8	7 1/2	A	106.79	213.58	305.11
51R	SX51R-EX	A	500	625	85	46	12	9 5/16	4 15/16	8 11/16	A	79.04	158.09	225.84
58R	SX58R-EX	A	600	750	85	46	12	9 1/4	7 1/8	7	A	64.01	128.02	182.89
65	SX65-EX	A	850	1060	150	78	12	11 1/4	7 7/16	7 9/16	A	78.25	156.51	223.59
75	SX75-EX	A	700	875	100	54	12	9 7/16	6 7/8	7 3/16	S	77.92	155.85	222.64
78	SX78-EX	A	800	1000	120	63	12	10 3/16	6 3/4	7 3/16	S	78.55	157.11	224.44
86	SX86-EX	A	650	810	100	54	12	9	6 13/16	8	A	78.27	156.55	223.64
T5/LB2/90	SX-T5/LB2/90-EX	A	600	750	85	46	12	9 1/2	6 15/16	6 15/16	A	78.45	156.90	224.14
T7/LB4/92	SX-T7/LB4/92-EX	A	730	910	125	75	12	12 7/16	6 15/16	6 15/16	A	150.26	300.53	429.33
H7/L4/94R	SX-H7/L4/94R-EX	A	800	1000	140	80	12	12 7/16	6 15/16	7 7/16	A	99.69	199.39	284.84
96R	SX96R-EX	A	600	750	100	54	12	9 1/4	6 7/8	6 7/8	A	73.47	146.94	209.91
101	SX101-EX	A	540	675	115	67	12	10 1/4	7 1/16	6 11/16	S	148.76	297.52	425.03
124R	SX124R-EX	A	700	875	100	54	12	10 3/16	6 7/8	8 7/16	A	80.04	160.09	228.70
151R	SX151R-EX	A	340	425	55	36	12	7 7/16	4 15/16	8 7/8	A	76.21	152.42	217.74
75DT	SX75DT-EX	A	700	875	100	54	12	9	7 13/16	8 1/8	A,S	81.82	163.65	233.79
78DT	SX78DT-EX	A	800	1000	120	63	12	10 3/16	6 15/16	8 1/8	A,S	82.48	164.97	235.67

The product descriptions, specifications and pricing were correct at the time this material was being prepared for printing. Our policy is one of continuous development and we reserve the right to change design, specifications or pricing at any time, without notice and without incurring obligation.

BATTERY SYSTEMS OF ALBUQUERQUE
 4380 ALEXANDER BLVD NE, SUITE C, ALBUQUERQUE, NM 87107
 PH: (505) 359-2370



DPS-50 PRICE EFFECTIVE 02/01/21



Distributed By:
BATTERY SYSTEMS
The Single Source Solution!

SUGGESTED CUSTOMER PRICES - ALL PRICES QUOTED EXCHANGE

BCI GRP SIZE	PART NUMBER	CORE CLASS	CCA					VOLTS	MAXIMUM DIMENSIONS INCHES			TERM TYPE	PRICE	DIST PRICE	SUGGESTED RETAIL
			CCA	CA	RC	AH			LENGTH	WIDTH	HEIGHT				
EXIDE® SPRINTER® - AUTOMOTIVE BATTERIES - MAINTENANCE FREE* - 2 YEAR FREE REPLACEMENT															
22NF	S22NF-EX	A	390	485	70	39	12	9 1/2	5 1/2	9 1/16	A	54.41	108.82	155.46	
24	S24-EX	A	600	750	110	59	12	10 3/16	6 3/4	8 5/8	A	57.64	115.29	164.70	
24F	S24F-EX	A	600	750	110	59	12	10 3/16	6 3/4	8 5/8	A	57.64	115.29	164.70	
25	S25-EX	A	550	685	100	54	12	9	6 3/4	8 3/4	A	59.89	119.79	171.13	
26	S26-EX	A	550	685	85	46	12	8 11/16	6 13/16	7 11/16	A	54.74	109.49	156.41	
26R	S26R-EX	A	550	685	85	46	12	8 11/16	6 13/16	7 11/16	A	54.44	108.89	155.56	
34	S34-EX	A	700	875	120	63	12	10 3/16	6 13/16	7 7/8	A	65.16	130.33	186.19	
35	S35-EX	A	550	685	100	54	12	8 15/16	6 3/4	8 3/4	A	59.21	118.43	169.19	
36R	S36R-EX	A	650	810	120	63	12	10 1/4	7 3/16	8 1/8	A	68.10	136.21	194.59	
40R	S40R-EX	A	600	750	100	54	12	10 5/8	6 15/16	6 15/16	A	73.25	146.51	209.30	
41	S41-EX	A	650	810	105	56	12	10 5/8	7	6 7/8	A	72.92	145.85	208.36	
42	S42-EX	A	500	625	75	41	12	9 1/4	6 7/8	6 7/8	A	62.10	124.21	177.44	
H5/L2/47	S-H5/L2/47-EX	A	600	750	90	55	12	9 1/2	6 7/8	7 1/2	A	77.56	155.12	221.60	
H6/L3/48	S-H6/L3/48-EX	A	700	875	110	60	12	11	6 7/8	7 1/2	A	85.95	171.91	245.59	
H8/L5/49	S-H8/L5/49-EX	A	850	1060	150	80	12	13 7/8	6 7/8	7 1/2	A	93.99	187.98	268.54	
51	S51-EX	A	450	560	70	39	12	9 5/16	4 15/16	8 11/16	A	56.14	112.29	160.41	
51R	S51R-EX	A	450	560	70	39	12	9 5/16	4 15/16	8 11/16	A	56.14	112.29	160.41	
56	S56-EX	A	580	725	90	49	12	9 15/16	5 15/16	8 3/8	A	63.48	126.96	181.37	
58	S58-EX	A	540	675	80	44	12	9 1/4	7 1/8	7	A	57.76	115.53	165.04	
59	S59-EX	A	600	750	100	54	12	10 1/16	7 1/2	7 1/2	A	61.63	123.27	176.10	
65	S65-EX	M	700	875	130	68	12	11 1/4	7 7/16	7 7/16	A	69.10	138.21	197.44	
70	S70-EX	A	550	685	85	46	12	8 1/8	6 15/16	7 3/16	S	54.80	109.60	156.57	
75	S75-EX	A	650	810	100	54	12	9 7/16	6 7/8	7 3/16	S	64.05	128.11	183.01	
78	S78-EX	A	700	875	120	63	12	10 3/16	6 3/4	7 3/16	S	70.23	140.47	200.67	
79	S79-EX	A	850	1060	150	78	12	12 1/2	7 1/16	7 3/8	S	89.88	179.77	256.81	
85	S85-EX	A	650	810	100	54	12	9	6 13/16	8	A	73.90	147.80	211.14	
86	S86-EX	A	600	750	90	49	12	9	6 13/16	8	A	69.71	139.43	199.19	
T6/LB3/91	S-T6/LB3/91-EX	A	700	875	100	54	12	10 15/16	6 15/16	6 15/16	A	86.61	173.23	247.47	
H7/L4/94R	S-H7/L4/94R-EX	A	750	935	130	75	12	12 7/16	6 15/16	7 7/16	A	94.36	188.72	269.60	
121R	S121R-EX	A	600	750	100	54	12	8 1/8	6 7/8	7 3/4	A	64.42	128.84	184.06	
46A24L	S-MIATA-EX	U	320	400	45	26	12	7 3/4	5	6 7/8	A	87.75	175.51	250.73	
75DT	S75DT-EX	A	550	685	85	46	12	9	7 13/16	8 1/8	A,S	65.97	131.95	188.50	
78DT	S78DT-EX	A	650	810	100	54	12	10 3/16	6 15/16	8 1/8	A,S	72.34	144.68	206.69	
EXIDE® - AUTOMOTIVE BATTERIES - 1 YEAR FREE REPLACEMENT															
24	E24-EX	A	550	685	85	46	12	10 3/16	6 3/4	8 5/8	A	50.40	100.81	144.01	
24F	E24F-EX	A	550	685	85	46	12	10 3/16	6 3/4	8 5/8	A	50.40	100.81	144.01	
26R	E26R-EX	A	500	625	80	44	12	8 11/16	6 13/16	7 11/16	A	47.61	95.22	136.03	
75	E75-EX	A	550	685	85	46	12	9 7/16	6 7/8	7 3/16	S	50.40	100.81	144.01	
EXIDE® ROADFORCE AGM HEAVY DUTY GROUP 31 BATTERIES - MAINTENANCE FREE* - 24 MONTH FREE REPLACEMENT															
31	XRF-31D-EX	B	950	1185	200	100	12	13	6 13/16	9 7/16	T	193.27	386.54	552.20	
31	RF-31D-EX	B	700	840	200	100	12	13	6 13/16	9 7/16	T	177.74	355.49	507.84	
EXIDE® EXTREME™ CYCLER / EXIDE® EXTREME™ POWER 1000 GROUP 31 BATTERIES - MAINTENANCE FREE* - 24 MONTH FREE REPLACEMENT															
31	31XHD-EX	B	700	840	195	134	12	13	6 13/16	9 7/16	T	107.31	214.62	306.60	
31	31XPD-EX	B	1000	1200	200	116	12	13	6 13/16	9 7/16	T	109.41	218.83	312.61	
31	31XPE-EX	B	1000	1200	200	116	12	13	6 13/16	9 7/16	A	109.41	218.83	312.61	
EXIDE® SELECT PERFORMANCE GROUP 31 BATTERIES - MAINTENANCE FREE* - 18 MONTH FREE REPLACEMENT															
31	31XHD-EX	B	925	1050	180	104	12	13	6 13/16	9 7/16	T	87.51	175.03	250.04	
31	31XHE-EX	B	925	1050	180	104	12	13	6 13/16	9 3/8	A	87.51	175.03	250.04	
31	31HD-EX	B	750	900	180	104	12	13	6 13/16	9 7/16	T	84.01	168.03	240.04	
31	31HE-EX	B	750	900	180	104	12	13	6 13/16	9 3/8	A	84.01	168.03	240.04	
EXIDE® COMMERCIAL SERIES GROUP 31 BATTERIES - MAINTENANCE FREE* - 18 MONTH FREE REPLACEMENT															
31	31D-EX	B	660	800	160	91	12	13	6 13/16	9 7/16	T	75.26	150.53	215.04	
31	31E-EX	B	660	800	160	91	12	13	6 13/16	9 3/8	A	75.26	150.53	215.04	

The product descriptions, specifications and pricing were correct at the time this material was being prepared for printing. Our policy is one of continuous development and we reserve the right to change design, specifications or pricing at any time, without notice and without incurring obligation.

BATTERY SYSTEMS OF ALBUQUERQUE
 4380 ALEXANDER BLVD NE, SUITE C, ALBUQUERQUE, NM 87107
 PH: (505) 359-2370



DPS-50 PRICE EFFECTIVE 02/01/21



Distributed By:



SUGGESTED CUSTOMER PRICES - ALL PRICES QUOTED EXCHANGE

BCI GRP SIZE	PART NUMBER	CORE CLASS	CCA					VOLTS	MAXIMUM DIMENSIONS INCHES			TERM TYPE	PRICE	DIST PRICE	SUGGESTED RETAIL
			CCA	CA	RC	AH			LENGTH	WIDTH	HEIGHT				
EXIDE® HEAVY DUTY COMMERCIAL SERIES & FARM BATTERIES – 12 MONTH FREE REPLACEMENT															
3EE	3EE-EX	A	370	440	100	65	12	19 1/4	4 1/4	8 9/16	A	83.63	167.26	238.94	
3ET	3ET-EX	B	460	550	120	78	12	19 1/4	4 1/4	9 9/16	A	91.23	182.46	260.66	
4D	4D-EX	D	1000	1200	320	156	12	19 9/16	8 5/16	10	A	150.92	301.84	431.20	
4DLT	4DLT-EX	D	820	970	250	125	12	20	8 1/8	8 1/8	A	137.69	275.38	393.40	
8D	8DAS-EX	E	1350	1620	450	267	12	20 7/8	11	10 3/8	T(LP1)	236.96	473.92	677.03	
8D	8DX-EX	E	1300	1560	435	218	12	20 3/4	11	10	A	165.27	330.55	472.21	
8D	8DX (312)-EX	E	1300	1560	435	208	12	22 5/16	11	10	B(312)†	171.33	342.67	489.53	
8D	8DX (313)-EX	E	1300	1560	435	218	12	22 5/16	11	10	B(313)†	171.33	342.67	489.53	
8D	8DX (314)-EX	E	1300	1560	435	218	12	22 5/16	11	10	B1(314)†	171.33	342.67	489.53	
8D	8DX (316)-EX	E	1300	1560	435	208	12	22 5/16	11	10	B(316)†	171.33	342.67	489.53	
8D	8D-EX	E	1155	1380	400	195	12	20 7/8	11	10	A	159.83	319.66	456.66	
8D	8DD-EX	E	1155	1380	400	195	12	20 7/8	11	10	T	171.27	342.55	489.36	
30H	30H-EX	B	700	850	180	104	12	13	6 15/16	9 5/8	A	105.66	211.33	301.90	
EXIDE® AUTOMOTIVE & LIGHT COMMERCIAL BATTERIES – 12 MONTH FREE REPLACEMENT															
1	1-EX	A	625	750	160	91	6	8 13/16	6 3/4	8 5/8	A	57.65	115.31	164.73	
2	2-EX	A	625	750	150	91	6	10 1/4	6 7/8	9 5/16	A	70.55	141.11	201.59	
EXIDE® HEAVY DUTY COMMERCIAL BATTERIES – 12 MONTH FREE REPLACEMENT															
3EH	3EH-EX	B	850	1020	280	143	6	19 1/4	4 1/4	9 7/8	A	84.83	169.66	242.37	
4	4-EX	B	975	1170	300	156	6	13	6 3/4	9 1/4	A	81.89	163.78	233.97	
4EH	4EH-EX	B	930	1110	300	156	6	19 1/4	5	10	A	128.03	256.06	365.80	
5D	5D-EX	B	850	1020	280	143	6	13 1/2	7 1/4	9 3/8	A	98.34	196.68	280.97	
EXIDE® HEAVY DUTY BATTERIES – COMMERCIAL GRADE – 12 MONTH FREE REPLACEMENT															
8V-1	8-1-EX	A	360	430	110	--	8	9 1/16	6 7/8	9	A	74.11	148.23	211.76	
EXIDE® NAUTILUS® STARTING – MARINE BATTERIES – MAINTENANCE FREE* – 1 YEAR FREE REPLACEMENT															
24	24MSXX-EX	A	800	1000	115	--	12	10 1/4	6 13/16	9 1/16	M (5/16)	76.00	152.01	217.16	
24	24MSX-EX	A	525	650	80	--	12	10 1/4	6 13/16	9 1/16	M (5/16)	56.59	113.19	161.70	
24	24MS-EX	A	450	525	65	--	12	10 1/4	6 13/16	9 1/16	M (5/16)	53.07	106.15	151.64	
27	27MSXX-EX	A	800	1000	180	--	12	12	6 13/16	9 7/16	M (5/16)	81.36	162.73	232.47	
EXIDE® NAUTILUS® DEEP CYCLE – MARINE/RV BATTERIES – 1 YEAR FREE REPLACEMENT															
24	24MDC-EX	A	400	500	140	73	12	10 1/4	6 13/16	9 7/16	M (5/16)	88.69	177.38	253.40	
27	27MDC-EX	A	550	675	182	93	12	12	6 13/16	9 7/16	M (5/16)	96.37	192.74	275.34	
31	31MDC-EX	B	650	830	205	104	12	13	6 13/16	9 7/8	M (3/8P, 5/16N)	110.24	220.49	314.99	
4D	4DMDC-EX	D	600	850	250	125	12	20 3/4	8 3/4	10 11/16	WNT2	204.58	409.17	584.53	
8D	8DMDC-EX	E	800	1200	400	193	12	20 3/4	11	10 11/16	WNT2	245.40	490.80	701.14	
EXIDE® NAUTILUS® DUAL PURPOSE EFB – EFB MARINE/RV BATTERIES – MAINTENANCE FREE* – 2 YEAR FREE REPLACEMENT															
24	EFB24MDP-EX	A	590	700	140	77	12	10 1/4	6 13/16	9 1/16	M (5/16)	103.91	207.83	296.90	
27	EFB27MDP-EX	A	675	800	160	90	12	12	6 13/16	9 7/16	M (5/16)	112.27	224.54	320.77	
EXIDE® NAUTILUS® DUAL PURPOSE – MARINE/RV BATTERIES – 1 YEAR FREE REPLACEMENT															
24	24MDP-EX	A	500	625	120	82	12	10 1/4	6 13/16	9 7/16	M (5/16)	69.77	139.54	199.34	
27	27MDP-EX	A	575	730	160	95	12	12	6 13/16	9 7/16	M (5/16)	79.12	158.24	226.06	
EXIDE® XTRA GAS POWERED GOLF CART STARTING BATTERY – 12 MONTH FREE REPLACEMENT															
26G	GC-26-EX	A	450	--	80	47	12	8 11/16	6 13/16	7 11/16	UT	56.66	113.32	161.89	
EXIDE® CUTTING EDGE® XTRA GARDEN TRACTOR & UTILITY BATTERIES – 6 MONTH FREE REPLACEMENT															
U1	U1XM-EX	U	350	435	--	--	12	7 3/4	5 3/16	7 1/4	X	46.86	93.73	133.90	
EXIDE® CUTTING EDGE® SELECT GARDEN TRACTOR & UTILITY BATTERIES – 6 MONTH FREE REPLACEMENT															
U1R	U1RSM-EX	U	300	375	--	--	12	7 3/4	5 3/16	7 1/4	X	34.54	69.09	98.70	
U1	U1SM-EX	U	300	375	--	--	12	7 3/4	5 3/16	7 1/4	X	34.54	69.09	98.70	
EXIDE® CUTTING EDGE® GARDEN TRACTOR & UTILITY BATTERIES – 6 MONTH FREE REPLACEMENT															
U1	GT-H-EX	U	250	310	--	--	12	7 3/4	5 3/16	7 5/16	X	29.91	59.82	85.46	
U1R	GT-R-EX	U	250	310	--	--	12	7 3/4	5 3/16	7 5/16	X	29.91	59.82	85.46	
U1	GT-EX	U	190	235	--	--	12	7 3/4	5 3/16	7 5/16	X	26.69	53.39	76.27	

The product descriptions, specifications and pricing were correct at the time this material was being prepared for printing. Our policy is one of continuous development and we reserve the right to change design, specifications or pricing at any time, without notice and without incurring obligation.

BATTERY SYSTEMS OF ALBUQUERQUE
 4380 ALEXANDER BLVD NE, SUITE C, ALBUQUERQUE, NM 87107
 PH: (505) 359-2370



DPS-50 PRICE EFFECTIVE 02/01/21



Distributed By:











SUGGESTED CUSTOMER PRICES - ALL PRICES QUOTED EXCHANGE

BCI GRP SIZE	PART NUMBER	CORE CLASS	RC		AH		VOLTS	MAXIMUM DIMENSIONS INCHES			TERM TYPE	PRICE	DIST PRICE	SUGGESTED RETAIL
			@ 25A	@ 75A	10HR	20HR		LENGTH	WIDTH	HEIGHT				
EXIDE® XTRA GOLF CART & ELECTRIC VEHICLE BATTERIES -- DEEP CYCLE -- 12 MONTH FREE REPLACEMENT														
GC2H	GC-145-EX	C	525	145	--	245	6	10 5/16	7 1/16	11 5/8	UT	115.43	230.86	329.80
GC2	GC-135-EX	C	480	135	--	226	6	10 5/16	7 1/8	10 7/8	LP1	112.16	224.32	320.46
GC2	GC-110-EX	C	390	110	--	186	6	10 5/16	7 1/8	10 7/8	LP1	97.82	195.64	279.49
GC8	GC8V-110-EX	C	290	110*	--	150	8	10 5/16	7 1/8	10 7/8	LP1	111.30	222.61	318.01

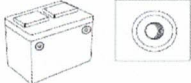
The product descriptions, specifications and pricing were correct at the time this material was being prepared for printing. Our policy is one of continuous development and we reserve the right to change design, specifications or pricing at any time, without notice and without incurring obligation.

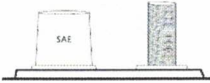
TERMINAL TYPES:

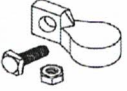
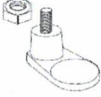
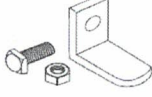
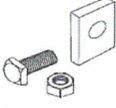
Terminal designs and designations supplied for reference only.

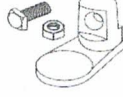
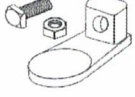
<p>SAE</p>  <p>TYPE A</p>	<p>JIS PENCIL POST</p>  <p>TYPE A3</p>	<p>SIDE TERMINAL</p>  <p>TYPE S</p>	<p>THREADED POST</p>  <p>TYPE T</p>	<p>MARINE</p>  <p>TYPE M</p>	<p>MARINE</p>  <p>TYPE M1</p>	<p>FLAG</p>  <p>TYPE M2</p>
<p>MARINE COMBINATION</p>  <p>TYPE WNT2</p>	<p>LAWN & GARDEN</p>  <p>TYPE X</p>	<p>LAWN & GARDEN</p>  <p>TYPE X1</p>	<p>GOLF CART & SCRUBBER</p>  <p>TYPE LT1</p>	<p>GOLF CART & SCRUBBER</p>  <p>TYPE LP1</p>	<p>GOLF CART & SCRUBBER</p>  <p>TYPE UT</p>	<p>GOLF CART & SCRUBBER</p>  <p>TYPE LT</p>

BATTERY SYSTEMS OF ALBUQUERQUE
 4380 ALEXANDER BLVD NE, SUITE C, ALBUQUERQUE, NM 87107
 PH: (505) 359-2370





- Stable Quality & High Reliability
- Sealed Construction
- Long Service Life, Float or Cyclic
- Maintenance-Free Operation
- Low Pressure Venting System
- Heavy Duty Grids
- Low Self Discharge

SUGGESTED CUSTOMER PRICES - ALL PRICES QUOTED EXCHANGE

PART NUMBER	BCI GROUP SIZE	CORE CLASS	VOLTAGE	TERMINAL	BIN NUMBER	AH CAPACITY @		MAXIMUM DIMENSIONS INCHES			WEIGHT (Tolerance ± 4%)		SUGGESTED RETAIL	LIST	WARRANTY MONTHS
						20 HR	10 HR	LENGTH	WIDTH	HEIGHT / TERM	LBS	KGS			
CENTENNIAL SMALL VALVE / AGM BATTERIES															
CB645	N/A	M	6	F1	CB926	4.5	--	2.76	1.85	3.90 / 4.13	1.59	0.72	\$15.44	\$18.95	6
CB1250	N/A	M	12	F1, F2	CB1766	5.0	--	3.54	2.76	3.98 / 4.21	3.53	1.60	\$29.43	\$34.95	6
CB1270	N/A	M	12	F1, F2	CB2100	7.0	--	5.94	2.56	3.70 / 3.94	4.50	2.04	\$35.00	\$41.95	6
CB1280	N/A	M	12	F1, F2	CB2390	8.0	--	5.94	2.56	3.70 / 3.94	4.92	2.23	\$39.84	\$47.95	6
CB12120	N/A	M	12	F1, F2	CB3986	12.0	--	5.94	3.86	3.74 / 3.98	7.94	3.60	\$66.43	\$79.95	6
CB12180	N/A	M	12	F3	CB5035	18.0	--	7.13	3.03	6.57	11.03	5.00	\$83.92	\$100.95	6
CB12260	N/A	U	12	F3	CB8177	26.0	--	6.54	6.89	4.92	17.86	8.10	\$136.28	\$163.95	6
CB12-35	U1	U	12	F7	CB8934	36.4	35.0	7.68	5.12	6.26 / 7.09	22.49	10.20	\$148.89	\$178.95	12
CB12-55	22NF	A	12	F11	CB15615	56.6	55.0	9.02	5.43	8.07 / 8.90	39.69	18.00	\$260.25	\$311.95	12
CENTENNIAL LARGE VALVE / AGM BATTERIES															
CB6-200	27	C	6	F12	CB26064	200.0	180.0	12.05	6.61	8.74 / 8.94	64.00	29.03	\$434.40	\$520.95	24
CB6-220	27	C	6	F12	CB27305	220.0	202.0	12.05	6.61	8.74 / 8.94	70.99	32.20	\$455.08	\$545.95	24
CB6-224	GC2	C	6	F14	CB25124	224.0	205.0	10.24	7.09	9.72 / 9.92	69.44	31.50	\$418.73	\$501.95	24
CB6-250	GC2	C	6	F14	CB28974	250.0	225.0	10.24	7.09	10.51 / 10.71	77.82	35.30	\$482.91	\$578.95	24
CB6-335	J305	D	6	F22	CB40798	348.0	335.0	11.61	7.00	13.62 / 14.33	105.82	48.00	\$679.96	\$815.95	24
CB6-400	L-16	D	6	F22	CB47943	416.0	400.0	11.61	7.00	15.91 / 16.73	126.76	57.50	\$799.05	\$958.95	24
CB12-85	24	C	12	F12	CB21265	85.0	80.0	10.24	6.65	8.27 / 8.46	54.67	24.80	\$354.41	\$424.95	24
CB12-105	27	C	12	F12	CB25614	105.0	100.0	12.07	6.63	8.27 / 8.46	66.14	30.00	\$426.91	\$511.95	24
CB12-115	31	C	12	F12	CB27565	115.0	110.0	12.91	6.77	8.54 / 8.74	73.19	33.20	\$459.41	\$550.95	24
CB12-120S	31	C	12	F7	CB25370	120.0	115.0	12.99	6.77	8.58 / 9.51	68.78	31.20	\$422.83	\$506.95	24
CB12-215	J185	D	12	L6	CB50375	224.0	200.0	15.04	7.05	13.82 / 14.57	140.00	63.50	\$839.59	\$1,007.95	24
CB12-210	4D	D	12	L6	CB49510	210.0	195.0	20.87	8.23	8.43 / 9.41	134.49	61.00	\$825.16	\$989.95	24
CB12-260	8D	D	12	L6	CB64395	270.0	260.0	20.47	10.55	8.66 / 9.65	169.75	77.00	\$1,073.25	\$1,287.95	24

The product descriptions, specifications and pricing were correct at the time this material was being prepared for printing. Our policy is one of continuous development and we reserve the right to change design, specifications or pricing at any time, without notice and without incurring obligation.

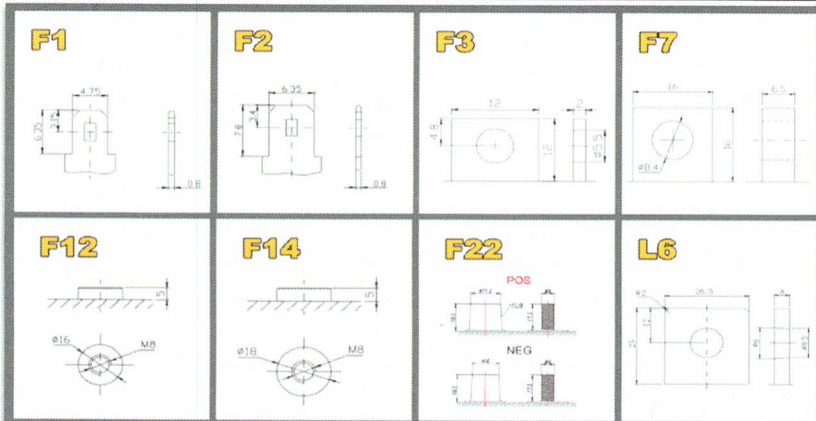

WE SUPPORT A CLEAN & GREEN ENVIRONMENT!

BATTERY SYSTEMS

BATTERY SYSTEMS OF ALBUQUERQUE
 4380 ALEXANDER BLVD NE, SUITE C, ALBUQUERQUE, NM 87107
 PH: (505) 359-2370

ODYSSEY[®] BATTERY

DRIVE IT TO EXTREMES



SUGGESTED CUSTOMER PRICES - ALL PRICES QUOTED EXCHANGE

BCI GROUP SIZE	PART NUMBER	CORE CLASS	BIN NUMBER	PHCA 5 SEC	SAE RATINGS			NOMINAL CAPACITY		RC	VOLTAGE	MAXIMUM DIMENSIONS INCHES			SUGGESTED RETAIL	STANDARD WARRANTY MONTHS	NON-STANDARD WARRANTY MONTHS
					CCA	HCA	MCA	20HR	10HR			LENGTH	WIDTH	HEIGHT			
POWER SPORTS - MOTORCYCLE, ATV & SPECIAL APPLICATION																	
n/a	PC310	M	OD17777	310	100	200	155	8	7	9	12	5.43	3.39	3.98	\$289.05	24	N/A
n/a	PC535	M	OD12155	535	200	315	270	15	14	25	12	6.70	3.90	6.24	\$197.64	24	N/A
n/a	PC545	M	OD10270	460	150	280	220	13	12	18	12	7.00	3.38	5.17	\$166.99	24	N/A
n/a	PC545MJ	M	OD11641	460	150	280	220	13	12	18	12	7.00	3.38	5.17	\$189.28	24	N/A
n/a	PC680	M	OD11730	520	170	350	280	16	16	24	12	7.27	3.11	7.55	\$190.73	24	N/A
n/a	PC680MJ	M	OD12815	520	170	350	280	16	16	24	12	7.27	3.11	7.55	\$208.37	24	N/A
n/a	PC680MJT	M	OD13780	520	170	350	280	16	16	24	12	7.27	3.11	7.55	\$224.07	24	N/A
POWER SPORTS - PERSONAL WATERCRAFT																	
n/a	PC625	M	OD12844	530	200	420	340	18	17	27	12	6.70	3.90	6.95	\$208.84	24	N/A
STANDARD AUTOMOTIVE / COMMERCIAL																	
n/a	PC925	A	OD17103	900	330	610	480	28	27	48	12	6.64	7.05	5.83	\$278.09	36	24
n/a	PC925L	A	OD17103	900	330	610	480	28	27	48	12	6.64	7.05	5.83	\$278.09	36	24
n/a	PC925MJ	A	OD18338	900	330	610	480	28	27	48	12	6.64	7.05	5.83	\$298.19	36	24
n/a	PC925LMJ	A	OD18338	900	330	610	480	28	27	48	12	6.64	7.05	5.83	\$298.19	36	24
n/a	PC925T	A	OD18206	900	330	610	480	28	27	48	12	6.64	7.05	5.83	\$296.04	36	24
n/a	PC925MJT	A	OD19874	900	330	610	480	28	27	48	12	6.64	7.05	5.83	\$323.15	36	24
n/a	PC925LMJT	A	OD19994	900	330	610	480	28	27	48	12	6.64	7.05	5.83	\$325.11	36	24
n/a	PC1200	A	OD21624	1200	540	860	725	42	40	78	12	7.87	6.66	7.60	\$351.61	36	24
n/a	PC1200T	A	OD23204	1200	540	860	725	42	40	78	12	7.87	6.66	7.60	\$377.31	36	24
n/a	PC1200LT	A	OD23437	1200	540	860	725	42	40	78	12	7.87	6.66	7.60	\$381.09	36	24
n/a	PC1200MJ	A	OD23996	1200	540	860	725	42	40	78	12	7.87	6.66	7.60	\$390.19	36	24
n/a	PC1200MJT	A	OD24821	1200	540	860	725	42	40	78	12	7.87	6.66	7.60	\$403.60	36	24
n/a	PC1200LMJT	A	OD25017	1200	540	860	725	42	40	78	12	7.87	6.66	7.60	\$406.77	36	24
n/a	PC1230/DT	A	OD28293	1230	760	1050	815	55	50	110	12	9.46	7.08	7.92	\$460.05	36	24
n/a	PC1700	B	OD31196	1550	810	1325	1175	68	65	142	12	13.03	6.63	7.78	\$507.25	36	24
n/a	PC1700S	B	OD31718	1550	810	1325	1175	68	65	142	12	13.03	6.63	7.78	\$515.73	36	24
n/a	PC1700T	B	OD32019	1550	810	1325	1175	68	65	142	12	13.03	6.63	7.78	\$520.64	36	24
n/a	PC1700MJ	B	OD33701	1550	810	1325	1175	68	65	142	12	13.03	6.63	7.78	\$547.99	36	24
n/a	PC1700MJS	B	OD34222	1550	810	1325	1175	68	65	142	12	13.03	6.63	7.78	\$556.45	36	24
n/a	PC1700MJT	B	OD34526	1550	810	1325	1175	68	65	142	12	13.03	6.63	7.78	\$561.40	36	24
IMPORT AUTOMOTIVE																	
48	48-720	B	OD24472	1250	723	950	842	69	63	130	12	10.91	6.89	7.50	\$397.92	36	24
49	49-950	B	OD25399	1350	770	1080	960	95	89	195	12	13.90	6.88	7.48	\$413.00	48	24
HEAVY DUTY AUTOMOTIVE / COMMERCIAL																	
25	PC1400/25	A	OD26913	1400	850	1150	950	65	55	130	12	9.46	6.84	8.69	\$437.61	48	24
35	PC1400/35	A	OD26913	1400	850	1150	950	65	55	130	12	9.46	6.84	8.69	\$437.61	48	24
34	PC1500/34	A	OD27602	1500	850	1250	1050	68	62	135	12	10.85	6.76	7.82	\$448.81	48	24
78	PC1500/78	A	OD30883	1500	850	1250	1050	68	62	135	12	10.85	6.99	7.12	\$502.16	48	24
34/78	PC1500/DT	A	OD29035	1500	850	1250	1050	68	62	135	12	10.85	7.08	7.82	\$472.11	48	24
65	PC1750/65	B	OD27559	1750	950	1350	1070	74	65	145	12	11.83	7.20	7.50	\$448.11	48	24
31	PC2150/31S	B	OD35925	2150	1150	1545	1370	100	92	205	12	13.06	6.89	9.59	\$584.15	48	24
31	PC2150/31T	B	OD37782	2150	1150	1545	1370	100	92	205	12	13.06	6.89	9.59	\$614.35	48	24
31	PC2150/31MJS	B	OD40717	2150	1150	1545	1370	100	92	205	12	13.06	6.89	9.59	\$662.07	48	24
31	PC2150/31MJT	B	OD40717	2150	1150	1545	1370	100	92	205	12	13.06	6.89	9.59	\$662.07	48	24
6T	PC2250ST	B	OD52078	2250	1225	1730	1550	126	114	240	12	11.26	10.59	9.17	\$846.80	48	24
MARINE																	
34M	PC1500/34M	B	OD30192	1500	850	1250	1050	68	62	135	12	10.85	6.76	7.82	\$490.92	36	24
n/a	PC1800/FT	D	OD57585	1800	1300	1600	1450	214	190	475	12	22.75	4.90	12.44	\$936.35	36	24
31M	PC2150/31M	B	OD40373	2150	1150	1545	1370	100	92	205	12	13.00	6.80	9.39	\$656.47	36	24

The product descriptions, specifications and pricing were correct at the time this material was being prepared for printing. Our policy is one of continuous development and we reserve the right to change design, specifications or pricing at any time, without notice and without incurring obligation.

BATTERY SYSTEMS
The Single Source Solution!

BATTERY SYSTEMS OF ALBUQUERQUE
4380 ALEXANDER BLVD NE, SUITE C, ALBUQUERQUE, NM 87107
PH: (505) 359-2370

WE SUPPORT A CLEAN & GREEN ENVIRONMENT!



SUGGESTED CUSTOMER PRICES - ALL PRICES QUOTED EXCHANGE

BCI GROUP SIZE	PART NUMBER	CORE CLASS	BIN NUMBER	SAE RATINGS				VOLTAGE	MAXIMUM DIMENSIONS INCHES			SUGGESTED RETAIL	FREE REPLACEMENT MONTHS	COMMERCIAL WARRANTY MOS.
				AH	CCA	CA	RC		LENGTH	WIDTH	HEIGHT			
OPTIMA REDTOP STARTING BATTERIES														
34/78	OPT-34/78	A	OP20146	50	800	1000	100	12	10 1/6	6 15/16	7 7/8	\$327.57	36	12
75/25	OPT-75/25	A	OP19145	44	720	910	90	12	9 3/8	6 13/16	7 3/4	\$311.31	36	12
25	OPT-25	A	OP18791	44	720	910	90	12	9 3/8	6 3/4	7 11/16	\$305.55	36	12
34	OPT-34	A	OP19697	50	800	1000	100	12	10 1/6	6 7/8	7 7/8	\$320.28	36	12
34R	OPT-34R	A	OP19676	50	800	1000	100	12	10 1/6	6 7/8	7 7/8	\$319.93	36	12
35	OPT-35	A	OP18794	44	720	910	90	12	9 3/8	6 3/4	7 11/16	\$305.59	36	12
78	OPT-78	A	OP20341	50	800	1000	100	12	10 1/6	7 5/16	7 1/4	\$330.75	36	12
6V	OPT-6V	A	OP15038	50	800	1000	100	6	10 1/6	3 5/8	8 1/8	\$244.52	36	12
OPTIMA YELLOWTOP DUAL-PURPOSE BATTERIES														
34/78	OPT-D34/78	A	OP24131	55	750	870	120	12	10 1/16	6 15/16	7 7/8	\$392.37	36	12
75/25	OPT-D75/25	A	OP22989	48	620	770	100	12	9 3/8	6 13/16	7 3/4	\$373.80	36	12
34	OPT-D34	A	OP23692	55	750	870	120	12	10 1/16	6 7/8	7 7/8	\$385.24	36	12
35	OPT-D35	A	OP22625	48	620	770	100	12	9 3/8	6 3/4	7 11/16	\$367.89	36	12
H6/48	OPT-H6	A	OP25966	72	800	928	140	12	10 17/18	6 8/9	7 12/25	\$422.21	36	12
51	OPT-D51	A	OP19640	38	450	575	66	12	9 5/16	5 1/6	8 15/16	\$319.35	36	12
51R	OPT-D51R	A	OP19640	38	450	575	66	12	9 5/16	5 1/6	8 15/16	\$319.35	36	12
DIN	OPT-DS46B24R	A	OP19640	38	450	575	66	12	9 5/16	5 1/6	8 15/16	\$319.35	36	12
31	OPT-D31T	B	OP29848	75	900	1125	155	12	12 13/16	6 9/16	9 3/8	\$485.33	24	12
31	OPT-D31A	B	OP29786	75	900	1125	155	12	12 13/16	6 9/16	9 3/8	\$484.33	24	12
27F	OPT-D27F	A	OP25828	66	830	1030	140	12	12 3/16	6 13/16	8 3/4	\$419.97	36	12
OPTIMA BLUETOP MARINE & RV BATTERIES														
27	OPT-D27M	A	OP25828	66	800	1000	140	12	12 3/16	6 13/16	8 3/4	\$419.97	24	12
34	OPT-34M	A	OP20889	50	800	1000	100	12	10 1/16	6 7/8	7 15/16	\$339.65	24	12
34	OPT-D34M	A	OP23445	55	750	870	120	12	10 1/16	6 7/8	7 15/16	\$381.23	24	12
31	OPT-D31M	B	OP29227	75	900	1125	155	12	12 13/16	6 9/16	9 3/8	\$475.24	24	12

The product descriptions, specifications and pricing were correct at the time this material was being prepared for printing. Our policy is one of continuous development and we reserve the right to change design, specifications or pricing at any time, without notice and without incurring obligation.



BATTERY SYSTEMS OF ALBUQUERQUE
 4380 ALEXANDER BLVD NE, SUITE C, ALBUQUERQUE, NM 87107
 PH: (505) 359-2370





**Working harder so
you can work longer!**



SUGGESTED CUSTOMER PRICES - ALL PRICES QUOTED EXCHANGE

BCI GROUP SIZE	PART NUMBER	CORE CLASS	BIN NUMBER	RESERVE CAPACITY @			AMPERE HOUR				VOLTAGE	MAXIMUM DIMENSIONS INCHES			SUGGESTED RETAIL	WARRANTY MOS.
				25A	56A	75A	5 HR	10 HR	20 HR	100 HR		LENGTH	WIDTH	HEIGHT		
US DEEP CYCLE 6 VOLT GOLF																
GC2	US1800	C	US10518	392	151	107	157	179	208	231	6	10 1/4	7 1/8	11 1/4	\$200.35	12
GC2	US2000	C	US11390	445	164	115	172	194	216	240	6	10 1/4	7 1/8	11 1/4	\$216.96	12
GC2	US2200	C	US12519	474	175	122	181	206	232	258	6	10 1/4	7 1/8	11 1/4	\$238.47	18
GC2	US125	C	US14878	517	198	140	198	220	242	269	6	10 1/4	7 1/8	11 1/4	\$283.39	12
US DEEP CYCLE 8 VOLT GOLF																
GC8	US8VGCE	C	US12017	222	90	60	129	142	155	172	8	10 1/4	7 1/8	11 1/4	\$228.89	18
GC8	US8VGC	C	US12902	325	118	82	133	151	170	189	8	10 1/4	7 1/8	11 1/4	\$245.76	18
GC8	US8VGCHC	C	US14003	345	136	95	147	164	183	203	8	10 1/4	7 1/8	11 1/4	\$266.72	12
GC8	US8VHATB	C	US17772	345	136	95	147	164	183	203	8	10 1/4	7 1/8	11 1/4	\$338.51	12
US DEEP CYCLE 6 VOLT SWEEPER/SCRUBBER, & MULTI PURPOSE																
1	DC1	A	US8657	178	-	47	-	-	97	-	6	8 3/4	6 7/8	9	\$164.89	12
GC2H	US145	C	US16721	562	217	154	213	236	251	279	6	10 1/4	7 1/8	11 7/8	\$318.49	12
901	US250	D	US15982	570	224	159	217	239	255	284	6	11 5/8	7 1/8	11 5/8	\$304.41	12
901	US250HC	D	US17588	635	250	178	239	263	280	311	6	11 5/8	7 1/8	11 5/8	\$335.01	12
902	US305E	D	US18458	660	256	182	245	273	290	322	6	11 7/8	7 1/8	14 5/8	\$351.59	12
902	US305	D	US22248	715	276	195	261	294	310	345	6	11 7/8	7 1/8	14 5/8	\$423.77	12
902	US305HC	D	US24473	790	304	215	283	322	340	378	6	11 7/8	7 1/8	14 5/8	\$466.16	12
L16/903	USL16E	D	US21838	795	287	198	281	312	360	400	6	11 7/8	7 1/8	16 3/4	\$415.96	12
L16/903	USL16	D	US25406	865	322	225	297	337	385	428	6	11 7/8	7 1/8	16 3/4	\$483.92	12
L16/903	USL16HCL	D	US27901	965	358	250	323	368	420	467	6	11 7/8	7 1/8	16 3/4	\$531.44	12
US DEEP CYCLE 12 GOLF, SWEEPER/SCRUBBER & MULTI PURPOSE																
GC12	US12VRX	D	US18613	292	110	77	122	138	155	172	12	13 1/8	7 1/16	11 3/8	\$354.53	12
GC12	US12VXC	D	US18613	292	110	77	122	138	155	172	12	13 1/8	7 1/16	11 3/8	\$354.53	18
GC12	US12VXZ	D	US18613	292	110	77	122	138	155	172	12	13 1/8	7 1/16	11 3/8	\$354.53	12
921	US185E	D	US21627	355	133	93	144	163	185	206	12	15 5/8	7 1/16	14 7/8	\$411.95	12
921	US185	D	US23437	398	151	106	158	178	200	222	12	15 5/8	7 1/16	14 7/8	\$446.43	12
921	US185HC	D	US25764	443	167	117	172	195	220	244	12	15 5/8	7 1/16	14 7/8	\$490.75	12
US DEEP CYCLE 12 MARINE & MULTI PURPOSE																
24	US24DCXC	A	US14057	145	54	38	68	76	85	95	12	11 3/16	6 3/4	9 3/4	\$267.76	12
27	US27DCXC	A	US15614	205	77	54	89	97	105	117	12	12 3/4	6 3/4	9 3/4	\$297.41	12
31	US31DCXC	B	US16921	225	84	59	99	114	130	144	12	13	6 3/4	9 3/4	\$322.31	12
US 6 & 2 VOLT RENEWABLE ENERGY / SOLAR																
GC2H	USRE-GC2HXC	C	US17310	507	193	136	194	217	242	269	6	10 1/4	7 1/8	11 7/8	\$329.71	24
L16/903	USRE-L16XC	D	US35458	915	348	245	317	352	401	446	6	11 7/8	7 7/8	16 3/4	\$675.39	24
L16/903	USRE-L162VXC	D	US34927	2826	1177	845	962	1024	1100	1250	2	11 7/8	7 7/8	16 3/4	\$665.28	24

BCI GROUP SIZE	CENTENNIAL PART NUMBER	CORE CLASS	BIN NUMBER	RESERVE CAPACITY @			CRANKING		AMPERE HOUR		VOLTAGE	MAXIMUM DIMENSIONS INCHES			SUGGESTED RETAIL	WARRANTY MOS.
				25A	56A	75A	@ 0 F	@ 32 F	5HR	20HR		LENGTH	WIDTH	HEIGHT		
US DEEP CYCLE AGM 6 VOLT																
GC2	USAGM-2000	C	US25852	475	177	124	710	855	182	213	6	10.24	7.09	10.79	\$492.41	12
GC2	USAGM-2224	C	US25952	450	171	120	710	855	175	224	6	10.20	7.09	9.72	\$494.32	12
901	USAGM-250	D	US31017	572	213	149	745	895	212	260	6	11.61	7.09	11.73	\$590.80	12
902	USAGM-305	D	US40970	736	291	208	720	865	273	312	6	11.61	7.09	14.41	\$780.37	12
L16/903	USAGM-L16	D	US47921	915	358	255	730	875	326	390	6	11.61	7.09	16.85	\$912.77	12
6V27	USAGM-6/27	B	US20798	450	162	112	830	1000	172	214	6	12.05	6.60	9.98	\$396.16	12
US DEEP CYCLE AGM 12 VOLT																
U1	USAGM-U1	U	US7622	51	19	13	230	280	30	35	12	7.68	5.12	7.09	\$145.19	12
27	USAGM-27	A	US20650	185	73	52	750	900	82	99	12	12.05	6.61	9.06	\$393.33	12
31	USAGM-31	B	US25560	190	73	52	800	960	85	100	12	13.00	6.85	9.37	\$486.87	12
921	USAGM-185	D	US55651	518	182	125	775	930	191	234	12	15.24	7.09	14.49	\$1,060.03	12

The product descriptions, specifications and pricing were correct at the time this material was being prepared for printing. Our policy is one of continuous development and we reserve the right to change design, specifications or pricing at any time, without notice and without incurring obligation.



BATTERY SYSTEMS OF ALBUQUERQUE
 4380 ALEXANDER BLVD NE, SUITE C, ALBUQUERQUE, NM 87107
 PH: (505) 359-2370

WE SUPPORT A CLEAN & GREEN ENVIRONMENT!





Give yourself the **ADVANTAGE** & make us your **SINGLE SOURCE SOLUTION** today!

SERVICE

Battery Systems works with our customers to create **CUSTOMIZED SERVICE PROGRAMS** specifically designed to fit all their business needs.

- Product & Service Surveys – Continuously analyze customer service programs to ensure we have the right products, programs & pricing in place.
- Service & Delivery Options - Regularly scheduled ROUTE VISITS, HOT SHOT & WILL CALL services available to ensure you have everything you need, when you need it!
- Fully Licensed Hazardous Material Carrier – Cradle to Grave Documentation provided to guarantee proper removal & transport of spent batteries to approved EPA Facilities.
- Consistent Customer Care – Provide customers with continuous training & support from dedicated Territory Sales Managers & local branch & home office teams.

SELECTION

As the largest independent battery distributor in the US, our **LOCAL, REGIONAL & NATIONAL DISTRIBUTION NETWORK** provides unrivaled service & selection.

- Comprehensive Stock Selection- By maintaining the largest inventory in the industry we provide our customers the Single Source Solution for all their battery needs.
- Flexible Warranty Programs – We have the right programs partnered with the right products to meet our customers' needs in any market condition.

VALUE

We're dedicated to keeping our customers' competitive in their markets by providing Quality Products aligned with **VALUE- DRIVEN PROGRAMS.**

- Effective Vendor Partnerships – Provide our customers the advantage of never having to sacrifice quality for value.

SERVICE – SELECTION – VALUE

Since 1955

CHECK & CHARGE POLICY

Battery Systems is dedicated to providing *Consistent Customer Care* by providing continuous training & support through varying features such as our Check & Charge Program. In the off chance that a customer's batteries are not performing to the level that is expected, Battery Systems will collect the batteries & perform a complimentary Check & Charge analysis.

PROCEDURE OVERVIEW

- Once the batteries have been collected from the customer & returned to the local Battery Systems facility, the batteries will begin the Check & Charge process within 24 hours in order to ensure minimal disruption in service to the customer.
- Once the batteries have gone through the complete testing cycle, Battery Systems warehouse will notify the key service representative assigned to the account the results of the Check & Charge analysis so that the customer can be notified right away.
- If the results of the test are that the batteries are not in good working condition, the customer will be notified & appropriate action will be taken, pending product warranty, age of battery, etc.
- If the results of the test show the batteries in good working condition, Battery Systems will have the batteries returned to the customer within 4 - 5 business days from the original pick-up date.
- When returning Check & Charge Batteries to the customer, Battery Systems will record:
 - Name of the driver responsible for the delivery
 - Date batteries are being returned
 - Check & Charge Batteries Delivery Receipt with signed POD
- Once the Check & Charge has been completed, the Battery Systems key service representative will review the outcome of the analysis with the customer & will provide additional information and/or training regarding the battery charging process as well as provide additional maintenance tips to help ensure optimized battery performance.

SAFETY / DISPOSAL

Battery Systems complies with all City, State and Federal mandates for storage, disposal, handling and transportation of hazardous materials.

A trained Battery Systems employee will make all deliveries directly to the specified locations. Delivery personnel are licensed to operate forklifts and trained in safe handling of batteries. Employees are also trained in emergency clean up and spill containment of batteries.

- Battery Systems vehicles are licensed and insured to transport hazardous materials.
- All delivery vehicles are equipped with fire extinguishers, spill containment kits, eyewash, and first aid kits.
- All Battery Systems warehouse facilities are certified for hazardous material storage.
- Battery Systems Hazardous Material License number is 136172.

Please see the attached list for all approved battery recycling centers.

To obtain copies of Battery Systems permits or any other documentation pertaining to storage, disposal, handling and transportation of hazardous materials, a request must be submitted to the Battery Systems Bids Department via email at: bids@batterysystems.net.

Gopher / Clarios

Gopher Resource Corporation
3385 South Highway 149
Eagan, MN 55121
EPA# MND006148092
800-354-7451

Stryten

Element Resources
Muncie Recycling Plant
2601 W Mt. Pleasant Blvd.
Muncie, IN 47302
US EPA ID# IND000717959
765-747-9980

Stryten / Clarios

RSR Middletown NY
Revere Smelting & Refining Corp.
65 Ballard Rd
Middletown, NY 10941
US EPA ID# NYD030485288
845-692-4414

Stryten Manufacturing

c/o Sanders Lead Co
1 Sanders Rd.
Troy, AL 36081
US EPA ID# ALD-046481302
334-566-1563

Stryten

Recicladora Industrial De Acumulado # 975
Enrique Hinojosa Calzado Ltd, c/o Mighty Auto
Parts
302 Nafta Blvd
Milo, Laredo, TX 78045
US EPA ID # 026140/9E/20
Rosy Garcia @ 956-722-4945

Stryten

Element Resources
Canon Hollow Recycling Plant
25102 Exide Drive
Forest City, MO 64451
US EPA ID# MOD030712822
660-446-3321

Stryten

The Doe Run Company - Resource Recycling
Division
18594 Highway KK
Boss, MO 65440
US EPA ID# MOD 059200089
800-633-8566

Clarios/JCI

Richer - El Paso, TX NBIMP
8700 Castner Dr
El Paso TX 79907

Gopher

Gopher Resource – Tampa
1901 N. 66th Street
Tampa, FL 33619
813-620-3260

M3

Interlink Trade Services
4301 West Military Hwy
McAllen, TX 78503
956-379-7832

Clarios

RSR Corp-Indy Virtual Plant
7870 W Morris St
Indianapolis IN 46206
317-247-1303

Clarios/JCI

Richer - Laredo, TX CORIMP
822 Union Pacific Blvd
Laredo, TX 78045
956-723-3122

M3

Interlink Trade Services
4900 George McVay Drive
McAllen, TX 78503

Trojan / US Battery

Quemetco West, LLC
Quemetco, Inc.
720 S. 7th Avenue
City of Industry, CA 91746